

Step 6 : Option setup

IMPORTANT : Changes to settings can only take place when power has been disconnected for at least 5 seconds.

On the board you will notice three in-line switches fitted to the right side of the DIP switches (Fig. 4). Only switch A is used.

Option switch A (when switched ON) provides two functions, a pre-flush and a purge option.

The pre-flush opens the valve for 1 second after the first 2 seconds of detection. This helps to prevent splashing by wetting the urinal bowl. After the pre-flush the timing continues.

The purge is initiated every 12 hours of non-use on either channel. This helps reduce smells from the urinal during periods of non-use.

Settings:

Switch A ON = Pre-flush plus purge

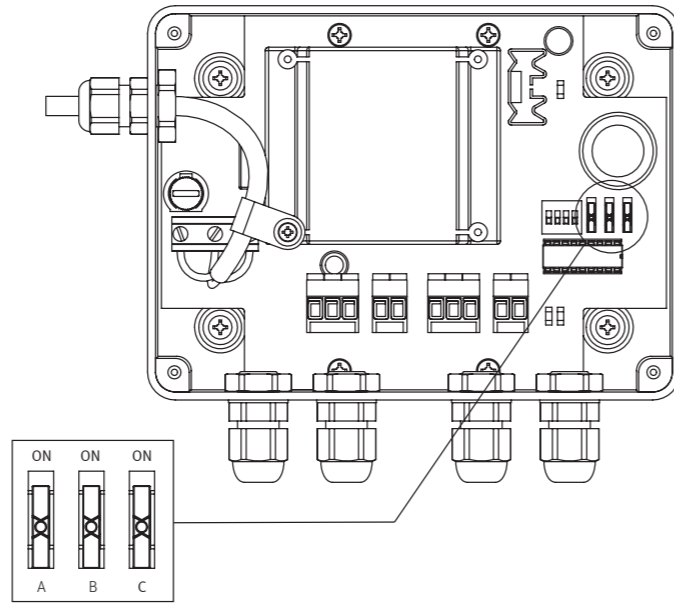

Step 7 : Time settings and basic operation

IMPORTANT : Changes to settings can only take place when power has been disconnected for at least 5 seconds.

Whilst the unit is still powered down the time settings can be setup.

The numbers printed on the switches (1, 2, 3, 4) simply identify the switch number; the actual time settings available are shown below:

Switch 1 ON = 1 seconds
 Switch 2 ON = 2 seconds
 Switch 3 ON = 4 seconds
 Switch 4 ON = 8 seconds

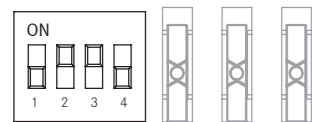

Example above (Fig 5) shows switch 2 and 3 ON. This gives a total flush-time of 6 seconds

Testing the sensors

A test routine is included for verifying the operation of the sensors.

After installation of external equipment, the supply should be connected.

To put the unit into test mode set DIP switches 1-4 to the OFF position.

When power is applied LED's 2 and 3 (Fig 2) will switch on corresponding to an object within range. For example, if sensor 1 (left hand channel) detects and object in range then LED 3 (left hand LED) will be on as long as the sensor detects the object. Sensor 2 operates LED 2 as above. This routine helps to identify if the sensors are detecting unwanted objects.

Operation:

When a person comes into range of a sensor a counter starts and after 10 seconds it is determined that the person is an actual user.

When the person leaves the sensing range the corresponding valve is opened for the set flush-time. However, a 2 second delay is built into the counter to allow the person to leave the range and return after or before the 10 seconds without effect on the counter. This also means that the valve will not open for 2 seconds after the user has left the area.

Each of the two channels operates independently, but both use the same settings.

Urinal Control System

Installation & Operating Instructions

UC07-001

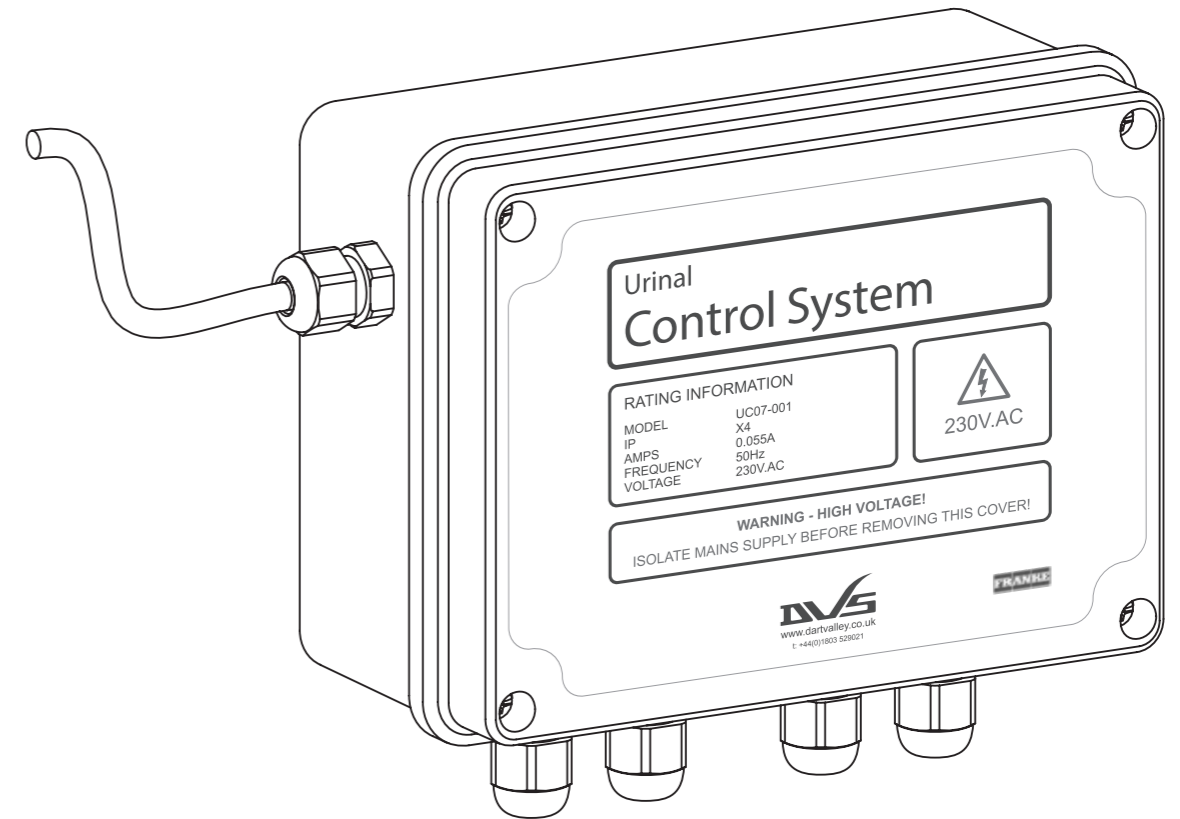

Step 1 : Safety First

These instructions relate to the use of the Urinal Control System only, any external or 'add-on' parts will be supplied with separate instructions.

It is recommended that the electrical part of the installation be carried out by a qualified electrician in accordance with the latest electrical regulations. It is also recommended that any plumbing is carried out by a qualified plumber.

IMPORTANT : Please read these instructions carefully and follow each stage in order!



230V.AC

Always isolate power when opening the control unit!

Step 2 : Kit Contents

A typical kit will include the following parts*:

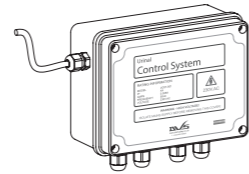

Control box

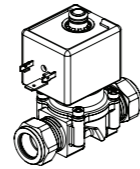

Solenoid valve

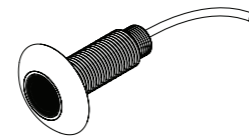

Sensor

*Not to scale

Step 3 : Typical installation

The control box should be located in a dry location and not exposed to dirt, dust or damp. The unit should be accessible when required, but not within easy reach of unauthorised persons.

It will be necessary to make adjustments and service the control box after installation, and in the future. Secure access areas and duct spaces are recommended.

The control box is not designed for direct surface mounting into washroom areas. Never open the cover with the supply live.

The routes that cables will take when connecting external equipment to the control box should also be planned at this stage.

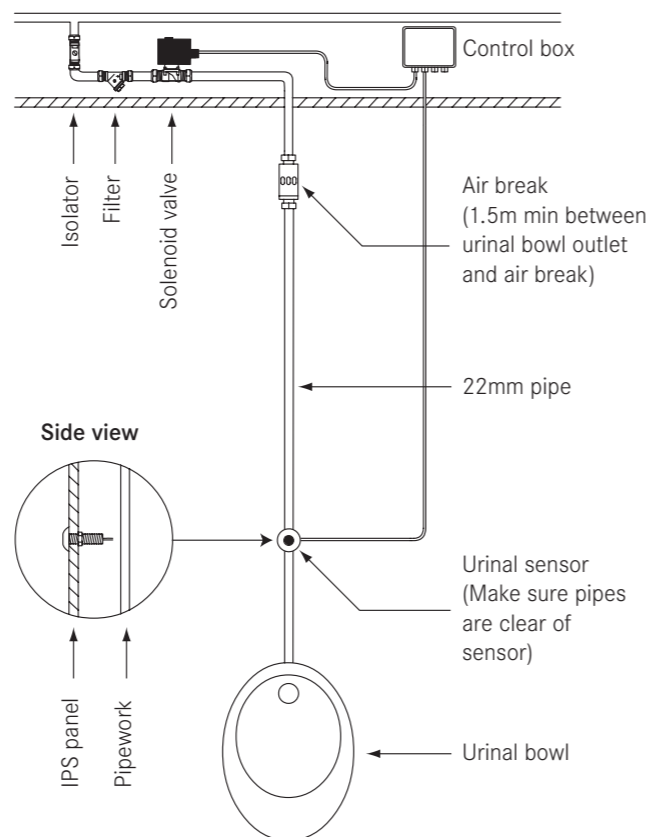

Step 4 : Board layout

- 1 Input connection - Sensor 1
- 2 Output connection - Valve 1
- 3 Input connection - Sensor 2
- 4 Output connection - Valve 2
- 5 Cable entry - Sensor 1
- 6 Cable entry - Valve 1
- 7 Cable entry - Sensor 2
- 8 Cable entry - Valve 2
- 9 Mains supply
- 10 Time setting switches
- 11 Option switches
- 12 LED 1 - For engineers / testing only
- 13 LED 2 - For engineers / testing only
- 14 LED 3 - For engineers / testing only
- 15 Fuse (replace with exact same type)

DO NOT extend cables
DO NOT leave badly fitted cables
DO NOT interfere with the mains flex
DO check all cables and connections
DO ask for advice if / when necessary

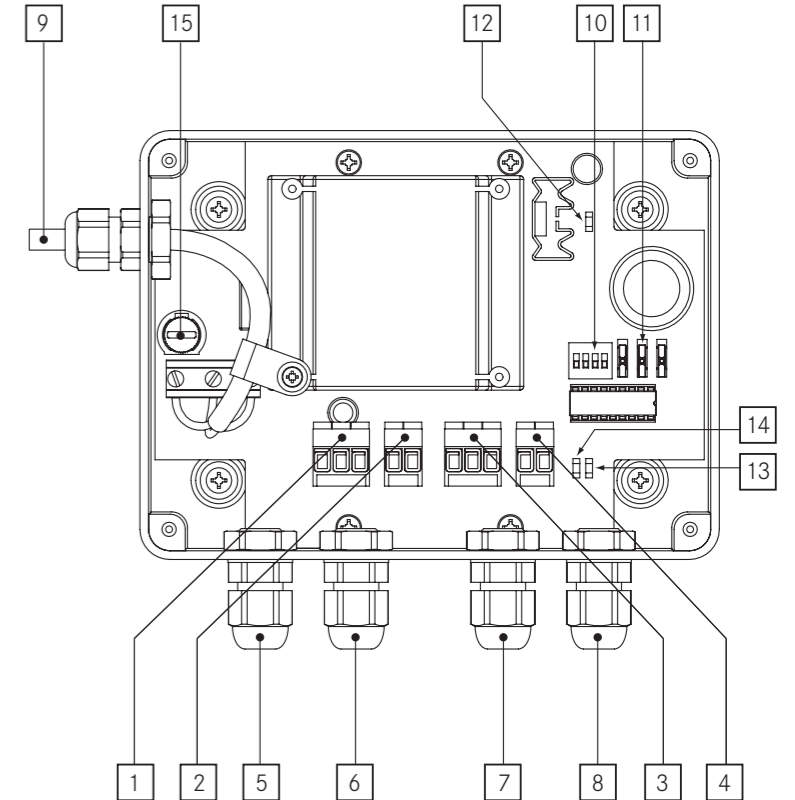

Step 5 : Fixing & wiring

The box should be securely fixed in a suitable location in a horizontal orientation, so that the front label is read correctly.

Remove lid to expose four fixing locations around the edge of the enclosure (see Fig. 3). These areas allow the fastening of the unit without removing the printed circuit board.

Drill through these marked areas away from the wall to avoid dust entering the control box, then hold control box in position against the wall and mark holes with a pencil. Remove box, drill and plug marked areas and fix the control unit with suitable fixings.

Connect the mains supply lead to a 230V ac supply via a fused spur, the fuse rating should be 3 Amps. The mains supply should NOT be initiated until all external equipment has been installed and wired.

Always read instructions supplied with external components and ensure that only the supplied equipment is connected to the control box.

Cables should enter the enclosure through the cable glands. Keep all connections tidy and do not allow cable to finish or hang in the transformer area.

It is recommended that each cable is fed through the relative cable gland into the enclosure; the cable can then be pulled out towards the fitter to allow the connector plugs to be fitted.

The connector plugs can be disconnected from the mating sockets when wiring external equipment, double check positions with the plug orientations as they only fit one way!

When each plug has been wired the cables can be pulled back through the cable glands, and the plug re-connected to the corresponding socket. Cables should not be left to torte or slack.

When all connections are made and checked, replace the lid and secure.

